

INSTRUCTION

you have

you need

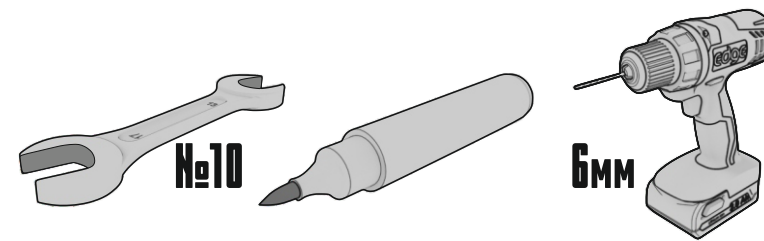
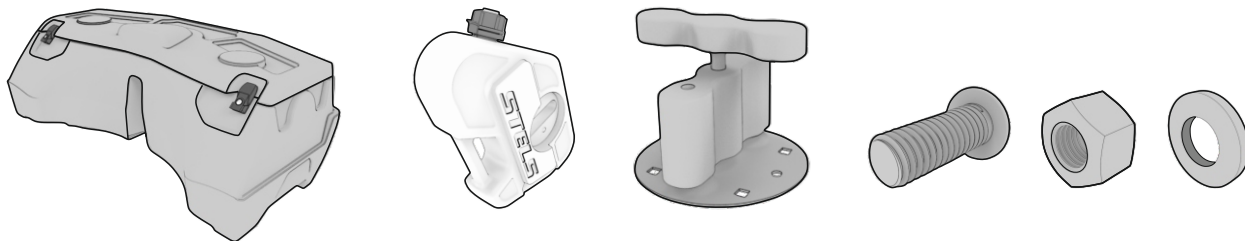

1. MARK

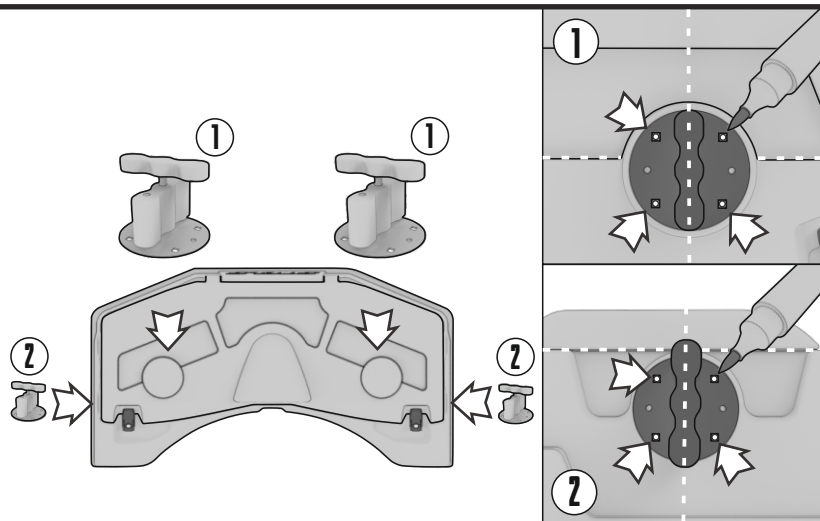
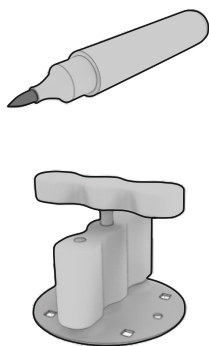

2. DRILL

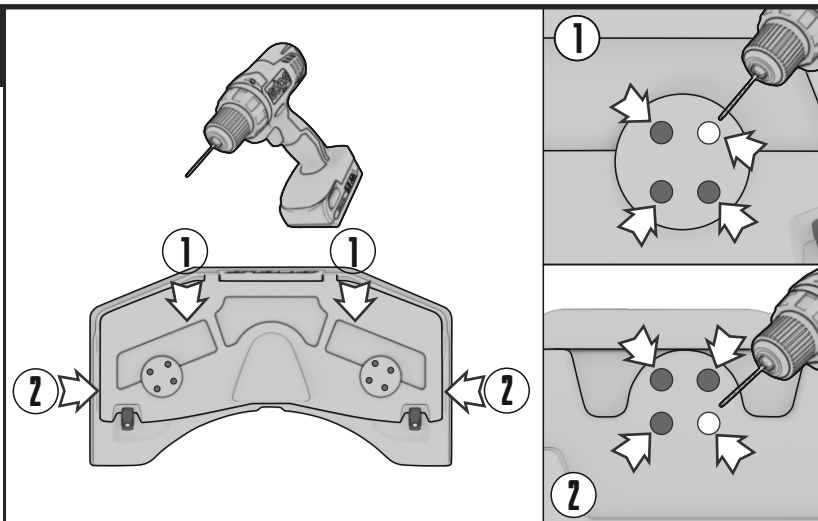

3. INSTALL

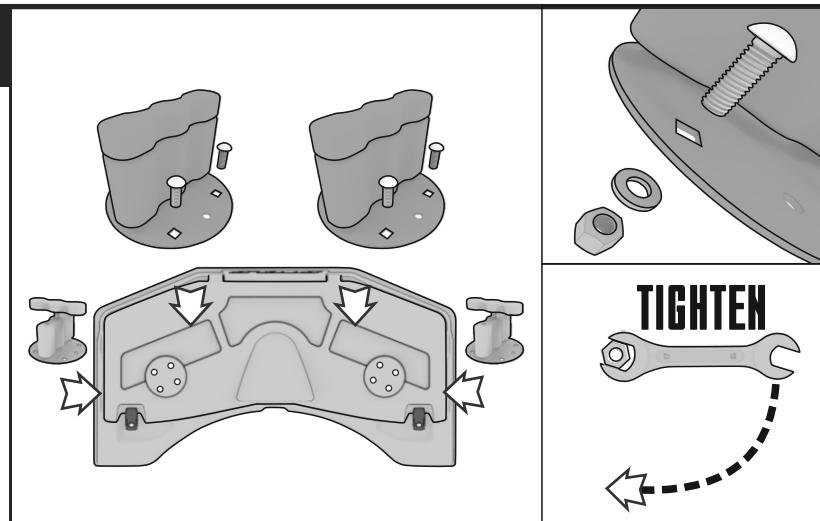
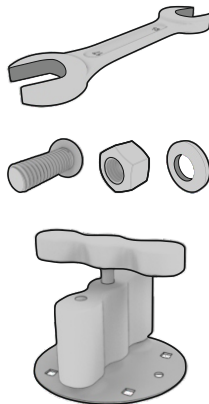

4. FIX

